

BASIC PHONE

Model 9835FWA

OPERATING INSTRUCTIONS

INTERQUARTZ®

1. FEATURES

- Tone/Pulse dialling
- Fully modular connection provides maximum ease of installation
- Telephone line powered, no mains battery power required.
- Ringer High/Low/Off control
- Ringer pitch control
- Flashing light indicates incoming call, message wait light can be added as an optional extra
- Recall Button for PABX facilities
- Redial and Pause function
- Mute button on handset to cut off transmission but not reception
- Wall mounting (optional)

2. GENERAL CONTROLS AND INDICATORS

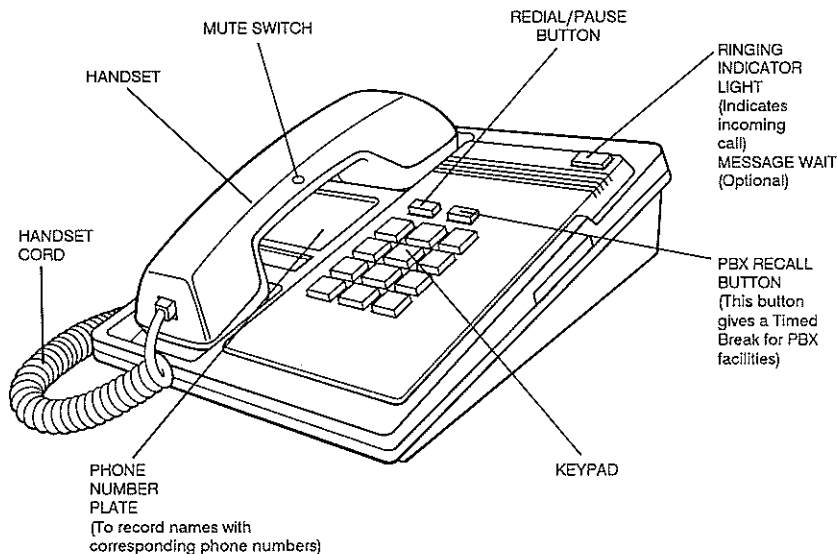

3. WALL MOUNT (OPTIONAL)

1. Release
Phone Number plate

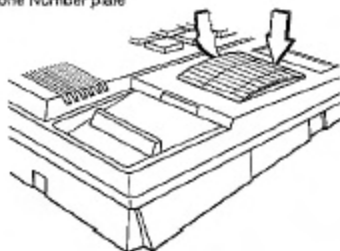

2. Insert Screw Driver into
slot and then pry to
release HANDSET RETAINER

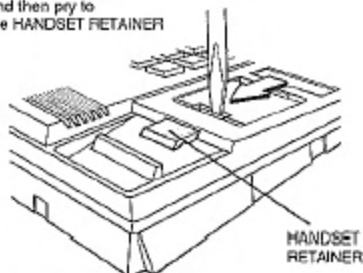

3. Turn around
HANDSET RETAINER
for wall mount

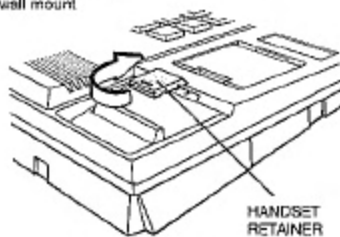

4. HANDSET RETAINER
for wall mount

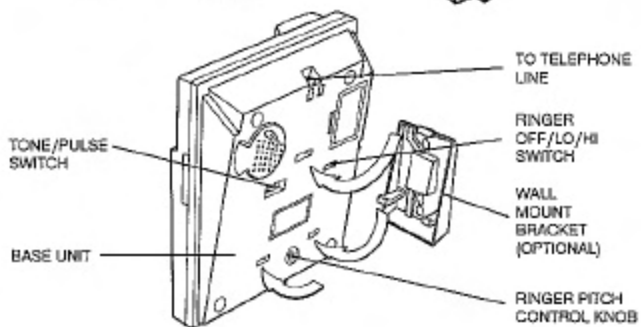
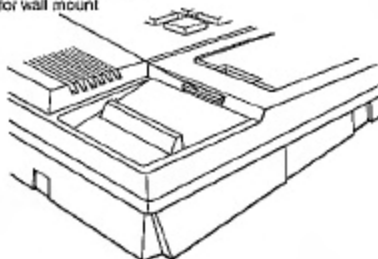

NOTE :

Wall mount bracket can be purchased from your authorised Interquartz dealer.

4. INSTALLATION

- 4.1 Connect one end of the handset cord modular plug to the left hand side of the telephone and the other end to the handset.
- 4.2 Selecting signalling type
Select Tone or Pulse dialling mode by sliding the Tone/Pulse switch to the position required.
- 4.3 Selecting Ringer Volume
Slide the ringer switch as required for HIGH/LOW/OFF.
- 4.4 Selecting Ringer Pitch
Rotate the ringer pitch control for ringing tone selection.
- 4.5 Connect one end of the telephone line to the back of the telephone and the other end to the wall modular socket.

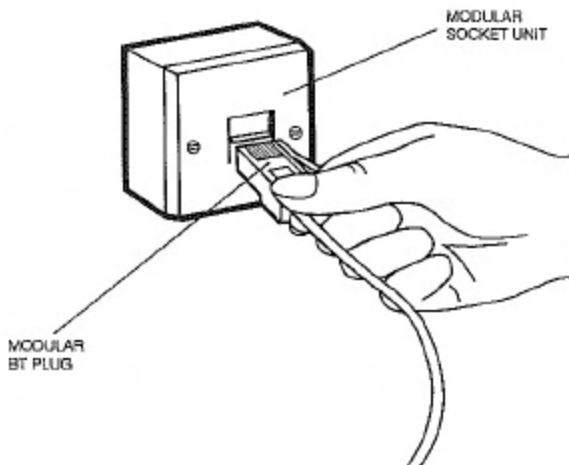

5. OPERATION

- To dial, pick up the handset, wait for dial tone and key in the number required.
- To terminate current connection simply replace the handset
- To dial a phone number with a pause between digits, pick up the handset, wait for dial tone, press the phone number such as trunk access code, follow by the Redial/Pause button and the rest of the phone number.
- To redial, pick up the handset, wait for dial tone and press the redial button.
- To mute, press and hold the mute button on the handset. The transmission through the handset is switched off.
- PBX Recall, when this phone is connected to a PABX, pressing the PBX Recall button will send a Recall signal to the PABX or exchange.

6. MAINTENANCE

This is a precision electronic device. Avoid rough handling and extreme temperatures. Use a mild detergent and a damp cloth when cleaning. Never use a strong cleaner. In the event of any operational failure, first check if the problem is caused by the exchange line. If you suspect that it may be the telephone then please contact your authorised INTERQUARTZ supplier for servicing.

Refer to warranty card for further details.