MONITOR BUSINESS PHONE

IQTEL300

OPERATING INSTRUCTIONS

INTERQUARTZ®

CONTENTS

1. FEATURES	2
2. GENERAL CONTROLS AND INDICATORS.....	3-6
3. ON HOOK DIAL FEATURE OPERATION	7
4. MEMORY FEATURE OPERATION	8-9
5. INSTALLATION	10
6. TECHNICAL ADJUSTMENTS	11-12
7. GENERAL CARE AND MAINTENANCE	13
8. WARRANTY	14

1. FEATURES

- Convenient pushbutton Tone dialling
- Fully modular connection provides maximum ease of installation
- Telephone line powered, unaffected by mains power interruption
- Desk mount (or optional wall mount)
- On-hook Dialling with speaker volume control
- User selectable ringer volume and pitch control
- Flashing light indicates incoming call
- PBX Recall facility (with selections to suit your PABX system)
- 3 one touch memories
- 10 abbreviated dial memories (two touch)
- Last number redial
- Pause function
- Mute switch on handset to cut off transmission
- Anti-ring back feature

2. GENERAL CONTROLS AND INDICATORS

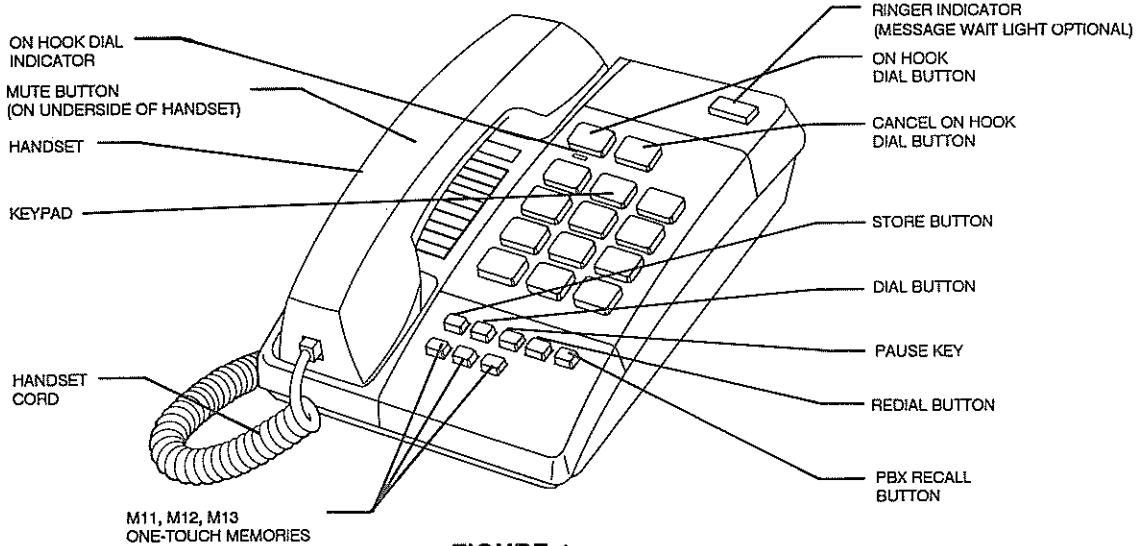
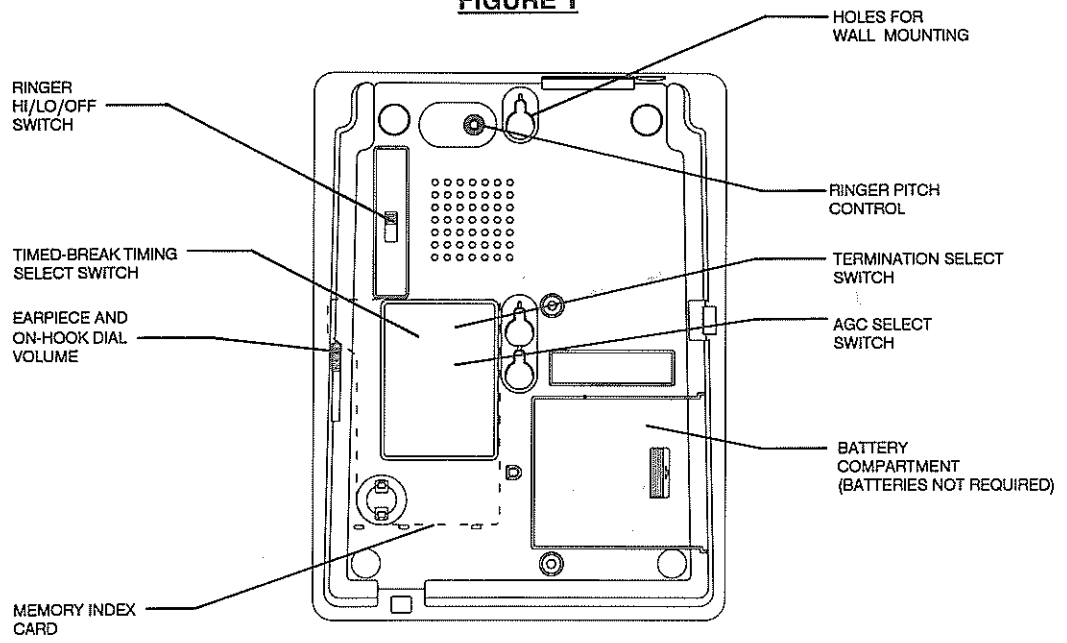

FIGURE 1



Bottom view of IQTEL 300

RINGER INDICATOR / MESSAGE-WAITING LIGHT (OPTIONAL)

Flashes when the telephone rings with an incoming call. It may also function as a 'message-waiting' indicator lamp (optional-consult your Interquartz dealer).

RINGER VOLUME SWITCH

The three available positions allow selection of OFF (no sound), LOW volume, and HIGH volume of the telephone's ringing sound during an incoming call.

RINGER PITCH CONTROL

Illustrated in Figure 1, the pitch of ringing sound may be altered by rotating the control.

KEYPAD

The standard alpha-numeric keypad is available for normal dialling.

VOLUME SLIDER

Used to adjust the volume of the Earpiece and On Hook Dial speaker. Set to midway for normal listening level.

PBX RECALL BUTTON

For use with PABX systems to invoke special PABX facilities such as call-hold or call-transfer which may be available in your PABX.

NOTE: See the TECHNICAL ADJUSTMENTS section for information regarding the correct settings to achieve compatibility with your PABX before attempting to use the PBX RECALL function.

Check your PABX User Guide, or consult your PABX supplier to determine its proper use with your PABX.

CRADLE SWITCH

Located in the handset cradle, this clear plastic lever is depressed by the handset when handset is placed in the cradle.

See the Hang-up function section below.

Hang-up function (*Anti-ring back feature*)

If the CRADLE SWITCH is tapped or depressed momentarily, the line (and the call) will be released automatically. After a minimum of 1 second, dial tone will again be heard and dialling may commence. This function prevents the false transmission of a PBX recall (hook-flash or timed-break recall signal) from the CRADLE SWITCH.

CAUTION: Tapping the CRADLE SWITCH as recommended in some PABX User Guides for use with call-hold or call-transfer procedures will not create a hook-flash. Use PBX RECALL BUTTON to invoke PABX features.

MEMORY INDEX CARD

May be used to record your telephone's number and other numbers which you have stored in the telephone's memories.

Swing out to view.

REDIAL BUTTON

This button will cause the last number dialled, up to 31 digits, to be redialled if it was dialled via the keypad. If the last number dialled was via one of the 13 memory locations then repeat the memory dial procedure.

See MEMORY FEATURE OPERATION section.

To Redial your last number using the REDIAL BUTTON:

1. If current connection is not yet terminated. Hang-up to terminate current connection.
2. Lift handset or press ON-HOOK DIAL button.
3. Wait for dial tone.
4. Press REDIAL.
5. The telephone will redial the last number (up to 31 digits long).

PAUSE BUTTON

This button will introduce a pause of 3.6 seconds in the dialling sequence.

Pause function

The pause command may be needed if your phone is connected to certain types of PABX or to any network where a pause is required.

For manual dialling

1. Lift HANDSET or press ON HOOK DIAL.
2. dial any digits required before the pause .
3. press PAUSE,
4. dial remaining digits.

For memory usage (storage procedure) :

1. Lift HANDSET or press ON HOOK DIAL,
2. press STORE,
3. dial digits required before the pause,
4. press PAUSE ,
5. dial digits required after the pause,
6. press STORE,
7. select and press desired one-touch or two-touch MEMORY button,
8. replace HANDSET or press CANCEL ON HOOK DIAL.

When dialled, this stored number will PAUSE at the appropriate place in the dialling sequence.

MUTE SWITCH

Press and hold this to mute the transmission for privacy. Release to resume conversation.

BASIC OPERATION

The IQTEL 300 Monitor can be used in the same way as a normal telephone; simply lift the HANDSET to answer an incoming call, or lift the HANDSET and dial on the KEYPAD to commence an outgoing call. Please refer to Section 3 and 4 for detailed operating instruction.

3. ON HOOK DIAL FEATURE OPERATION

As an adjunct to the HANDSET, this feature allows you to monitor your call's progress without using the HANDSET. Note that you must use the HANDSET to conduct your conversation.

Outgoing call using ON HOOK DIAL :

1. press ON HOOK DIAL; adjacent indicator will illuminate,
2. dial the required number on the KEYPAD or via one of the 13 memory dialling locations,
3. listen to the call's progress,
4. lift the HANDSET to speak, or press CANCEL ON HOOK DIAL to terminate the call.

Changing from HANDSET to ON HOOK DIAL during a call:

1. press and hold ON HOOK DIAL,
2. replace the HANDSET in the cradle,
3. release ON HOOK DIAL; adjacent indicator will illuminate.

Note: When using the ON HOOK DIAL feature, pressing the CANCEL ON HOOK DIAL button will release line. If you wish to make an immediate subsequent ON HOOK DIAL call, press ON HOOK DIAL again and dial tone will be returned to you.

4. MEMORY FEATURE OPERATION

All memories are able to store any combination of numeric entries including PAUSE, * and #. Memories or memory locations are especially useful for storing PABX features / functions access codes such as those required for call-hold or call-divert.

ONE-TOUCH MEMORIES - M11, M12, M13

These buttons provide easy dialling of often-used numbers. Each memory can store 16 digits.

Storing a number :

1. Lift HANDSET or press ON HOOK DIAL,
2. press STORE,
3. enter the telephone number (16 digits maximum),
4. press STORE,
5. press M11, M12, or M13,
6. replace HANDSET or press CANCEL ON HOOK DIAL.

Dialling a number :

1. Lift HANDSET or press ON HOOK DIAL,
2. wait for dial tone
3. press M11, M12, or M13

TWO-TOUCH MEMORIES - 0 to 9

Accessible via the alpha-numeric KEYPAD, 10 memories are available to store numbers up to 16 digits long.

Storing a number :

1. Lift HANDSET or press ON HOOK DIAL,
2. press STORE,
3. enter telephone number (16 digits maximum),
4. press STORE,
5. press any button from 0 or 1 or 2 etc. to 9 as your desired memory location,
6. replace HANDSET or press CANCEL ON HOOK DIAL.

Dialling a number :

1. Lift HANDSET or press ON HOOK DIAL,
2. wait for dial tone,
3. press DIAL,
4. press button 0 or 1 or 2 etc. to 9 as your desired memory to be dialled.

CASCADE DIALLING

The contents of any memory can be 'cascaded' or added together with additional manual dialling or other memories. In cascade dialling, make sure that each dialling sequence is completed before activating the next.

5. INSTALLATION

GENERAL

1. Install the HANDSET CORD and LINE CORD to the appropriate sockets,
2. Connect the telephone to your system,
3. Set the Ringer volume and Ringer pitch control as desired.

WALL MOUNTING

1. Fit the optional WALL MOUNT BRACKET to the wall and attach the telephone to it.
2. To enable the HANDSET to be supported in the cradle, follow the procedure shown in Figure 2 to reverse the HANDSET RETAINER.

1. Release INTERQUARTZ Name Plate

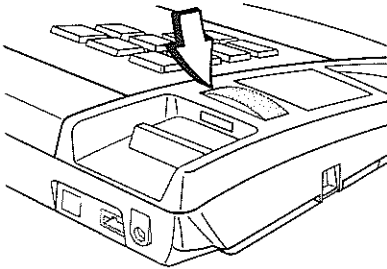

2. Insert Screw Driver into slot and then pry to release HANDSET RETAINER

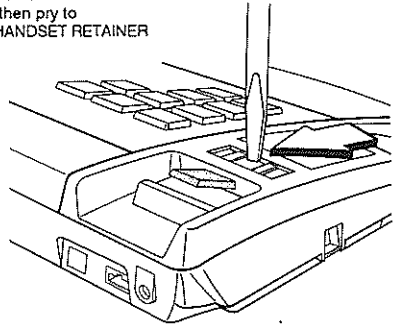

3. Rotate retainer 180° and re-insert retainer into slot

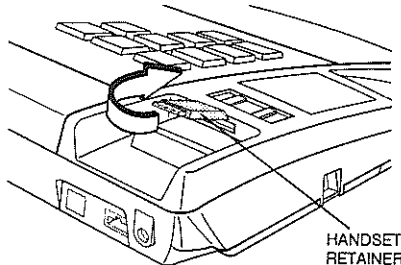

4. HANDSET RETAINER

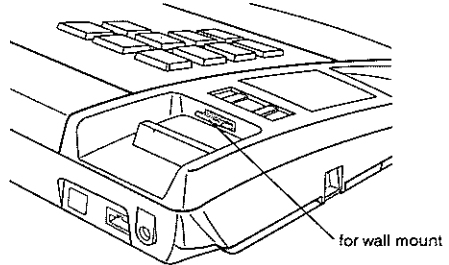

FIGURE 2 : Wall Mounting

6. TECHNICAL ADJUSTMENTS FOR CORRECT OPERATION

Warning - the following instructions are for an authorised INTERQUARTZ technician or service agent. Alterations should be made with care and proper instructions.

PBX RECALL SETTINGS - refer to Fig. 3

To achieve compatibility with all PABXs, the PBX RECALL BUTTON may be selected to execute different timed-break durations by a switch on the telephone underside.

1. Determine the setting required for your PABX,
2. Remove the Timed-break Timing switch cover,
3. Set the Timed-break Timing accordingly by sliding the switch to the appropriate position at 700ms or 350ms or 200ms or 100ms,
4. Replace the Timed-break Timing switch cover,

If in doubt, contact your PABX supplier or your INTERQUARTZ dealer.

The telephone, unless pre-set by your dealer / installer, will be factory set at 350ms Timed-break Timing.

COMPLEX / 600 OHMS AND AGC A / AGC B SELECTORS

Intended to provide enhanced compatibility with all line conditions, these controls influence the sidetone (the sound of your own voice that you hear in the receiver) of the handset. These selectors, unless pre-set by your dealer / installer, will be factory set to complex and AGC B. These selections should not be altered without prior consultations with your PABX supplier or INTERQUARTZ dealer. Note that for direct lines and PABX outdoor extensions (i.e. any long line extensions) the factory settings should not be altered. If in doubt, contact your INTERQUARTZ dealer. FIGURE 3 describes their locations and settings.

CAUTION: Please exercise care when adjusting all selectors described above as they and their surrounding electronic components maybe damaged by rough treatment. It is also recommended that all adjustments be made with the telephone disconnected from the telephone line.

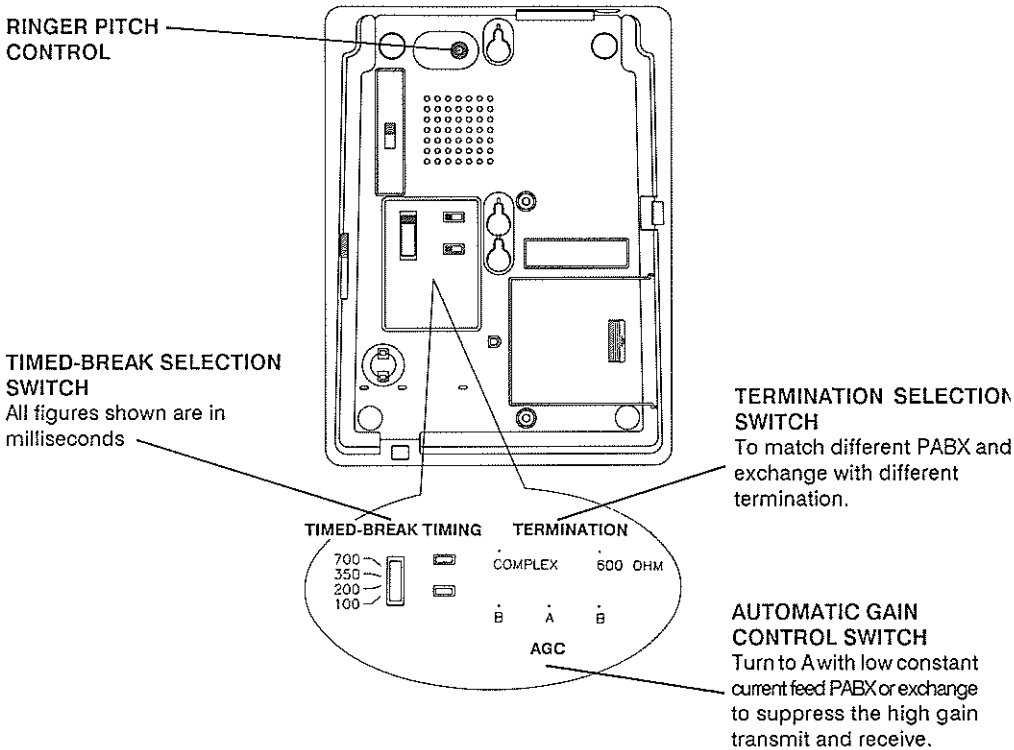

FIGURE 3

7. GENERAL CARE AND MAINTENANCE

This telephone is a precision electronic instrument. While in use or storage, care should be taken to avoid rough handling, extreme temperatures, and damp or dirty environments.

Cleaning

NEVER use aerosol sprays or other chemical agents or substances which leave a residue (furniture polish for example).

Use a mild detergent and a damp clean cloth when cleaning. Do not allow moisture to enter the telephone's interior - damage may result!

FAILURE TO OPERATE AND SERVICE DIFFICULTIES

If you are satisfied with the operation of your telephone service, your installation is completed. However, if telephone service problems occur at any time, it is recommended that the installation procedure described in this manual be re-checked.

If a fault occurs, try to determine if the fault is with the telephone, or with the network or system to which the telephone is connected :

- * Disconnect the "suspect" telephone, and test the line with a substitute telephone. If the telephone service then operates satisfactorily, the fault is in the "suspect" telephone.

- * Test the "suspect" telephone on a known good line. If the fault still occurs, the fault is in the "suspect" telephone.

Consult your Interquartz dealer for further advice if necessary.

8. WARRANTY

Interquartz New Zealand Limited warrants the original purchaser against faulty material or workmanship for a period of one year.

This warranty excludes damage due to misuse, improper maintenance, lightning strikes or unauthorised repairs or modifications and excludes freight or postage costs to / from your local authorised service centre unless otherwise arranged. Consequential loss not included.

WALL-MOUNT BRACKET (OPTIONAL)

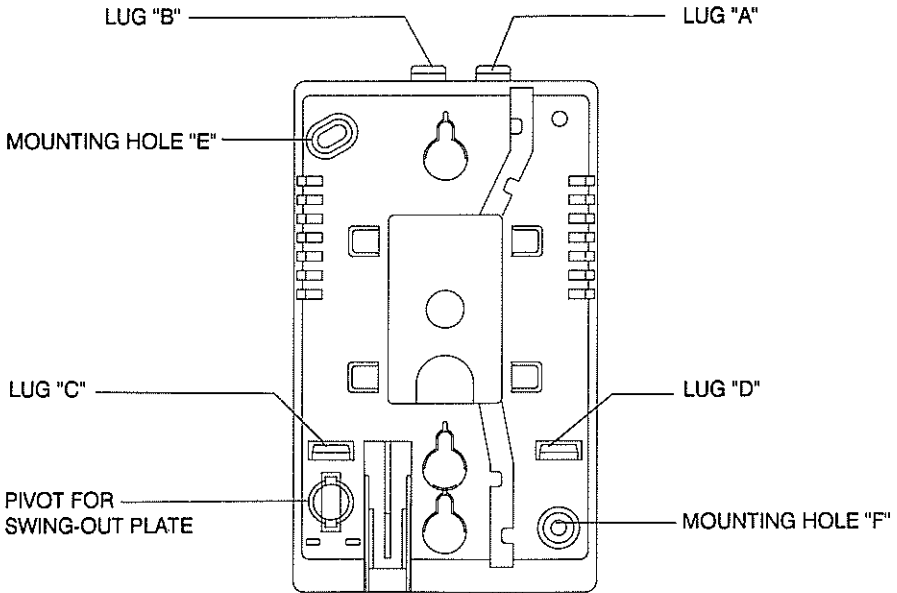

Please note:

1. This Wall bracket may be secured onto the wall by using mounting holes "E" and "F".
2. Lugs to break off before wall mounting the phone:

TELEPHONE MODELS	BREAK OFF LUGS
Model IQTEL 80 / 98380 Model IQTEL 300 / 98381 Model IQTEL E1 / 9838E Model IQTEL ET / 98383 Model IQTEL E2 / 98582 Model IQTEL E3 / 98583	"B" and "D"
Model IQTEL 25 / 9825	"A" and "C"
Model IQ300 / 98353 Model 9835FWA	"A" only